

MODEL SR560

LOW-NOISE PREAMPLIFIER



1290-D Reamwood Avenue
Sunnyvale, CA 94089 U.S.A.
(408) 744-9040

Copyright © 1989, 1990, 1997, 1999
Stanford Research Systems
All Rights Reserved.

Revision 2.5
(08/2001)

INTRODUCTION AND SETUP

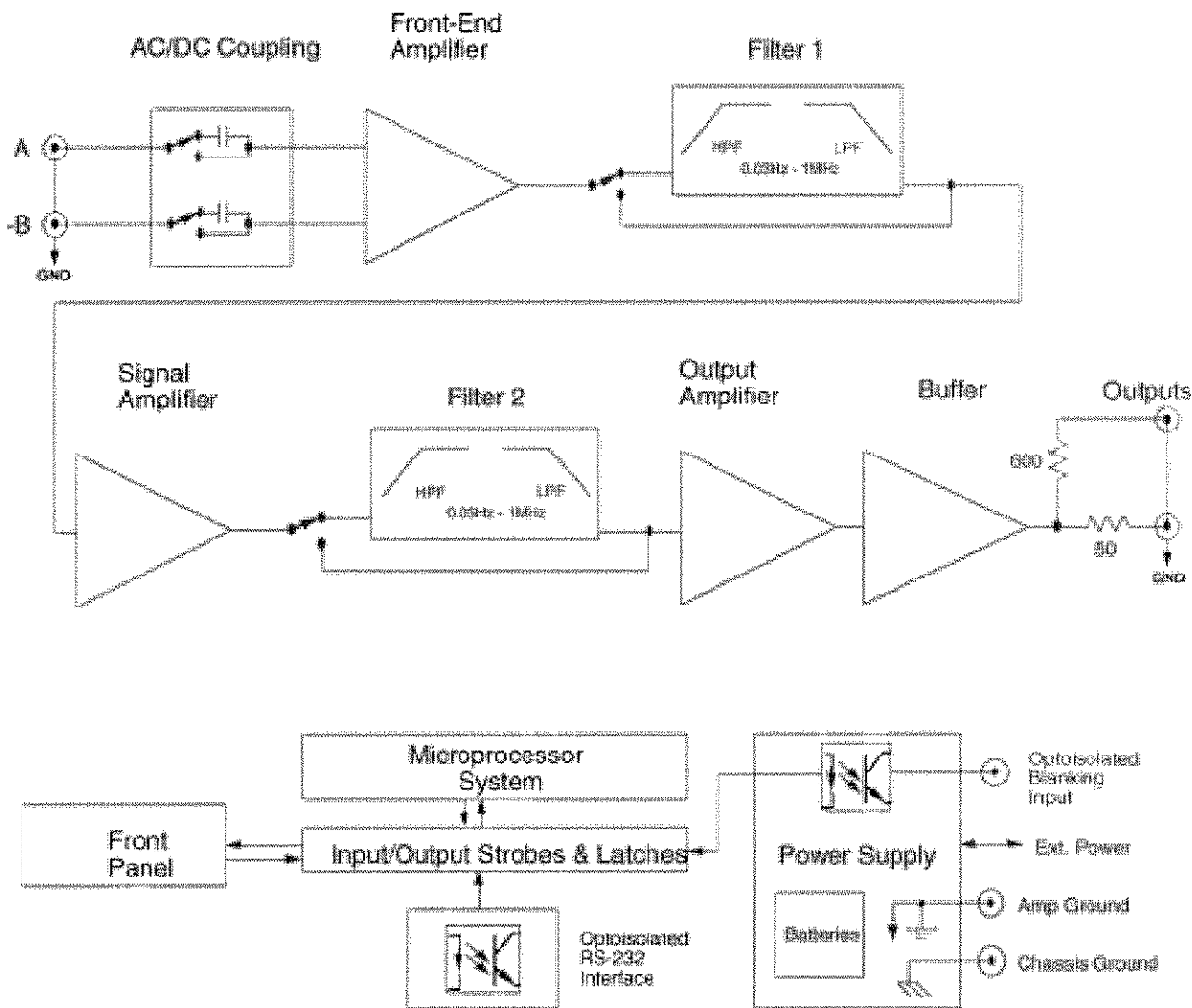

Figure 1: SR560 Block Diagram

INSTRUMENT OVERVIEW

The SR560 architecture is diagrammed above. The instrument provides DC-coupled low-noise amplification of single-ended and true differential input signals at gains of 1 to 50,000. Two configurable R-C filters are provided to selectively condition signals in the frequency range from DC to 1 MHz. The user can choose high dynamic reserve or low noise settings, and can invert the output relative to the input. The SR560 normally operates with a fully floating ground and can be viewed as an "in-line-

BNC amplifier" with the amplifier ground isolated from the chassis and the AC power supply. Opto-isolated input blanking control and listen-only RS-232 interface lines are provided for instrument control. Digital noise is eliminated by shutting down the microprocessor's oscillator except during the short time required to alter the instrument's configuration, either through a front-panel pushbutton or through an RS-232 command. Internal sealed lead-acid batteries provide 20 hours of line-

INTRODUCTION AND SETUP

independent operation. Rear panel banana jacks provide access to the internal regulated power supplies (or batteries) for use as a bias source.

PREPARATION FOR USE

*****CAUTION*****

This instrument may be damaged if operated with the LINE VOLTAGE SELECTOR card set for the wrong applied AC input source voltage or if the wrong fuse is installed.

Line Voltage

When the AC power cord is connected to the unit and plugged into an AC outlet, the unit automatically switches the amplifier power source from internal battery operation to line operation. The internal batteries are charged as long as AC power is connected.

The SR560 can operate from a 100 V, 120 V, 220 V or 240 V nominal AC power source having a line frequency of 50 or 60 Hz. Before connecting the power cord to a power source, verify that the LINE VOLTAGE SELECTOR card, located in the rear-panel fuse holder of the unit, is set so that the correct AC input voltage value is visible.

Conversion from one AC input voltage to another requires a change in the fuse holder's LINE VOLTAGE SELECTOR card position and a new fuse. Disconnect the power cord, slide the fuse holder cover to the left and rotate the fuse-pull lever to remove the fuse. Remove the small printed circuit board. Select the operating voltage by orienting the printed circuit board. Press the circuit board firmly into its slot, so the desired voltage is visible. Rotate the fuse-pull lever back into its normal position and insert the correct fuse into the fuse holder.

Line Fuse

Verify that the correct line fuse is installed before connecting the line cord to the unit. For 100 V and 120 V, use a 1 Amp fuse and for 220 V and 240 V, use a 1/2 Amp fuse.

Line Cord

The SR560 has a detachable, three-wire power cord with a three-contact plug for connection to both the power source and protective ground. The protective ground connects to the accessible metal parts of the instrument except for BNC shields.

To prevent electrical shock, always use a power source outlet that has a properly grounded protective-ground contact.

Ventilation

Always ensure adequate ventilation when operating the SR560. The unit will generate heat while charging dead batteries.

Power-Up

All instrument settings are stored in nonvolatile memory (RAM backed-up) and are retained when the power is turned off. They are not affected by the removal of the line cord. If the power-on self test passes, the unit will return to the settings in effect when the power was last turned off. If an error is detected or if the backup battery is exhausted, the default settings will be used. Additionally, if the RESET key is held down when the power is turned on, the instrument settings will be set to the defaults shown below:

<u>Parameter</u>	<u>Setting</u>
SOURCE	Channel A
COUPLING	DC
INVERT	OFF

INTRODUCTION AND SETUP

ROLLOFF	bypassed
HIGH-PASS	0.03 Hz, +6 dB/oct
LOW-PASS	1 MHz, -6 dB/oct
GAIN MODE	High Dynamic Reserve
GAIN	20, calibrated
LISTEN	ON
DEVICE ADDRESS	As per SW601

Repackaging for Shipment

The original packing materials should be saved for reshipment of the SR560. If the original packing materials are not available, wrap the instrument in polyethylene sheeting or equivalent and place in a strong box, cushioning it on all sides by at least three inches of high-density foam or other filler material.

Use in Biomedical Applications

Under certain conditions, the SR560 may prove to be unsafe for applications involving human subjects. Incorrect grounding, component failure, and excessive common-mode input voltages are examples of conditions in which the instrument may expose the subject to large input currents. Therefore, Stanford Research Systems does not recommend the SR560 for such applications.

Warning Regarding Use with Photomultipliers

The front-end amplifier of this instrument is easily damaged if a photomultiplier is used improperly with the amplifier. When left completely unterminated, a cable connected to a PMT can charge to several hundred volts in a relatively short time. If this cable is connected to the inputs of the SR560, the stored charge may damage the front-end FETs. To avoid this problem, provide a leakage path of about 100 k Ω to ground inside the base of the PMT to prevent charge accumulation.

Accessories Furnished

- Power cable
- Operating Manual

Environmental Conditions

OPERATING

Temperature: 10°C to 40°C

Relative Humidity: <90% Non-condensing

NON-OPERATING









Temperature: -25°C to +65°C

Relative Humidity: <95% Non-condensing

Warning regarding battery maintenance

Batteries used in this instrument are seal lead acid batteries. With usage and time these batteries can leak. Always use and store this instrument in the feet-down position. To prevent possible damage to the circuitboard, it is recommended that the batteries be periodically inspected for any signs of leakage.

Symbols you may find on SRS products.

Symbol	Description
	Alternating current
	Caution - risk of electric shock
	Frame or chassis terminal
	Caution - refer to accompanying documents
	Earth (ground) terminal
	Battery
	Fuse
	On (supply)
	Off (supply)

SPECIFICATIONS

SR560 LOW-NOISE PREAMPLIFIER SPECIFICATIONS CHART	
Inputs	Single-ended or true differential
Impedance	100 M Ω + 25 pF, DC-coupled
Maximum Inputs	1 VDC before overload; 3 V peak to peak max AC coupled; protected to 100 VDC
Maximum Output	10 Vpp
Noise	<4 nV/ $\sqrt{\text{Hz}}$ at 1 kHz
CMRR	>90 dB to 1 kHz, decreasing by 6 dB / octave (20 dB / decade) above 1 kHz
Gain	1 to 50,000 in 1-2-5 sequence vernier gain in 0.5% steps
Frequency Response	Gains up to 1000 ± 0.5 dB to 1 MHz ± 0.3 dB to 300 kHz
Gain Stability	200 ppm / $^{\circ}\text{C}$
DC Drift	5 $\mu\text{V}/^{\circ}\text{C}$ referred to input (DC coupled)
Filters	0.03 Hz to 1 MHz, 10% typical accuracy
Distortion	0.01% typical
Power	100, 120, 220, 240 VAC (50/60 Hz), 60 Watts Max Internal Batteries: 3 x 12 V, 1.9 Ah sealed lead-acid (rechargeable)
	± 12 VDC in / out through rear panel banana jacks.
Battery Life	20 hours nominal 250-1000 charge / discharge cycles
Charge Time	4 hours to 80% of capacity
Mechanical	1/2 Rack-Mount width, 3 1/2" height, weight 15 lbs.
Dimensions	14-7/8" x 8-1/8" x 3-1/2"
Warranty	1 year parts and labor on materials and workmanship

SPECIFICATIONS

OPERATION AND CONTROLS

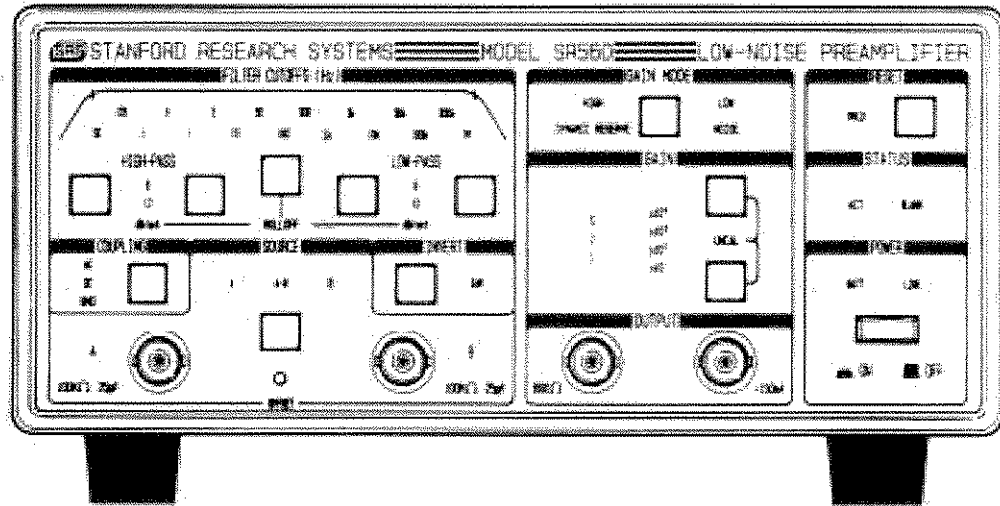

Figure 2: SR560 Front Panel

FRONT PANEL OPERATING SUMMARY

The operation of the SR560 Low-Noise Preamplifier has been designed to be as simple as possible. The effect of each keypress on the front panel is reflected in the change of a nearby LED. The front panel LED's will remain lighted at all times unless dip switch SW601 (accessible through the bottom cover of the unit) positions 3 and 4 are placed in the "off" position. All front panel functions can be controlled through the rear-panel RS-232 interface.

Power

The SR560 is turned on by depressing the POWER switch. When disconnected from AC power, the unit will operate for approximately 20 hours on internal sealed lead-acid batteries. Up to 200 mA of unregulated battery power is available at the rear panel banana jacks as long as the power switch is in the ON position. Battery life will be reduced when the unit is providing external power through the rear panel jacks. When operating on batteries, the front panel "BATT" indicator will be

lighted. As the batteries near exhaustion, this indicator will change from green to red, indicating that the unit should be connected to AC power to charge the batteries.

When connected to an AC power source, amplifier power is derived from regulated line power, and the internal batteries are automatically charged. When operating on AC power, the front panel "LINE" indicator is on to indicate the source of amplifier power. Charging status is indicated on the rear panel by the "CHARGE" and "MAINTAIN" LED indicators.

Source

There are two input connectors located in the **SOURCE** section of the front panel. The pushbutton located between them selects either single-ended (**A** or **B**) or differential (**A-B**) inputs.

The **A** and **B** inputs are voltage inputs with 100 M Ω , 25 pF input impedance. Their connector shields are completely isolated from chassis ground, but can be made

OPERATION AND CONTROLS

common with chassis ground by connecting the "AMP GROUND" and "CHASSIS GROUND" banana jacks on the rear panel of the SR560. When connected to AC power, the chassis of the unit is always connected to the grounding conductor of the AC power cord. The inputs are protected to 100 VDC but the DC input should never exceed 10 Vp. The maximum DC input before overload is 1 V peak.

The **COUPLING** pushbutton selects the method of connecting the **A** and **B** inputs to the amplifier. The inputs can be AC (0.03 Hz - 3 dB) or DC-coupled, or the inputs to the amplifier can be internally grounded with the **A** and **B** input BNC's left floating. This feature makes for simple offset nulling, particularly useful when operating the amplifier DC-coupled at high gains. Please refer to CALIBRATION AND REPAIR -- OFFSET ADJUSTMENT for information on the offset nulling procedure.

NOTE: When the coupling is set to AC, a 0.03 Hz cutoff high-pass filter is always engaged. All high-pass filter modes can still be selected while AC-coupled, but the 0.03 Hz filter will always be in, even if the filters are set to DC. Because one of the two filter sections is always used as a high pass when AC coupling is selected, low-pass filters are only available with a 6 dB / octave rolloff.

The **INVERT** pushbutton allows the user to invert the output of the instrument with respect to the input when operating with single-ended or differential inputs. The **INVERT** LED displays the output sense relative to the input for all **SOURCE** settings.

Filters

The SR560 contains two identical 1st-order R-C filters whose cutoff frequencies and topology (high-pass or low-pass) are controlled from the front panel. The maximum bandwidth of the instrument is 1

MHz. The filters in the **FILTER CUTOFFS** section can be configured in the following six ways:

- i. high-pass filter at +12 dB / octave
- ii. high-pass filter at +6 dB / octave
- iii. high-pass filter at +6 dB / octave, and low-pass filter at -6 dB / octave (band-pass)
- iv. low-pass filter at -6 dB / octave
- v. low-pass filter at -12 dB / octave
- vi. no filters in the signal path

The filter settings are controlled by the **ROLLOFF**, **HIGH-PASS** and **LOW-PASS** pushbuttons. Each time the **ROLLOFF** pushbutton is pressed the instrument configures the two R-C filters to conform to the progression shown above. The four **ROLLOFF** LED's give a visual indication of the current filter configuration. For the **HIGH-PASS** filter the left pushbutton serves to decrease its cutoff frequency. The two pushbuttons for the **LOW-PASS** filter function in an analogous manner.

When the **FILTER CUTOFFS** section is configured solely as high-pass or low-pass (i, ii, iv and v), the cutoff frequency is illuminated by one of sixteen LED's in the range from 0.03 Hz to 1 MHz, and the slope of the rolloff is shown by one of the four **ROLLOFF** LED's. When the filter section is configured as band-pass (iii), the cutoff frequencies are illuminated by two LED's. The frequency setting on the left marks the cutoff for the high-pass filter, and the setting on the right is the cutoff for the low-pass filter. The two 6 dB / oct **ROLLOFF** LED's are also illuminated. In this case the two cutoffs can be set to the same frequency to provide a narrow bandpass. When both filters are removed from the signal path (vi) all rolloff and cutoff frequency LED's are extinguished from the **FILTER CUTOFFS** section and the DC LED is on.

NOTE: High pass filters are not available for the four highest frequency settings. See the note under **Source: Coupling** for

OPERATION AND CONTROLS

information on using filters with the amplifier in AC coupled mode.

Gain Mode

The allocation of gain throughout the instrument is set using the **GAIN MODE** pushbutton. The Gain Mode is displayed by two indicator LED's: HIGH DYNAMIC RESERVE and LOW NOISE. For a given gain setting, a HIGH DYNAMIC RESERVE allocates the SR560's gain toward the output stages after the filters. This prevents signals, which are attenuated by the filters from overloading the amplifier. The LOW NOISE setting allocates gain toward the front-end in order to quickly "lift" low-level (nV range) signals above the instrument's noise floor.

Gain

The instrument's gain is increased or decreased using the GAIN pushbuttons. Gain settings from 1 to 50,000 are available and are displayed as the product of a factor 1, 2 or 5 and a multiplier (none (i.e. 1), 10, 100, 1,000 or 10,000). In addition to these fifteen fixed gain settings, the user may specify arbitrary gains through the UNCAL feature. To set an uncalibrated or arbitrary gain the user must press both Gain buttons simultaneously, lighting the UNCAL LED. In this mode by pressing the Gain Up or Gain Down pushbuttons, the user may reduce the calibrated gain in roughly 1% increments from 100% down to 0% of the selected gain. In contrast to other front-panel functions, when in UNCAL the instrument's key-repeat rate will start slowly and increase to a limit as long as either Gain button is depressed. Simultaneously pressing both Gain buttons once again will restore the unit to the previously calibrated gain setting, and turn off the UNCAL LED.

Output

The outputs of the instrument are located within the **OUTPUT** section of the front panel. Two insulated BNCs are provided: a 600 Ω output and a 50 Ω output. The amplifier normally drives high impedance loads and the instrument's gain is calibrated for high impedance loads. When driving a 600 Ω load via the 600 Ω output (or a 50 Ω load via the 50 Ω output) the gain of the amplifier is reduced by two. The shields of all the front-panel BNC's are connected together and form the amplifier's floating ground.

Reset

The OVLD LED indicates a signal overload. This condition can occur when a signal is too large or the dynamic reserve is too low. Reducing the gain, reducing the input signal and/or switching to the HIGH DYNAMIC RESERVE setting should remedy this condition. If an overload occurs with filter settings of long time constants, the RESET pushbutton will speed the SR560's recovery from overload.

Status

The ACT LED indicates communications activity over the SR560's optoisolated RS-232 port. Please refer to **Appendix A: Remote Programming** for further details on programming the instrument via RS-232.

The BLANK LED indicates the optoisolated **BLANKING** input (on the rear panel of the SR560) is active. The SR560 responds to a blanking input by internally grounding the amplifier signal path after the front end and before the first filter stage.

OPERATION AND CONTROLS

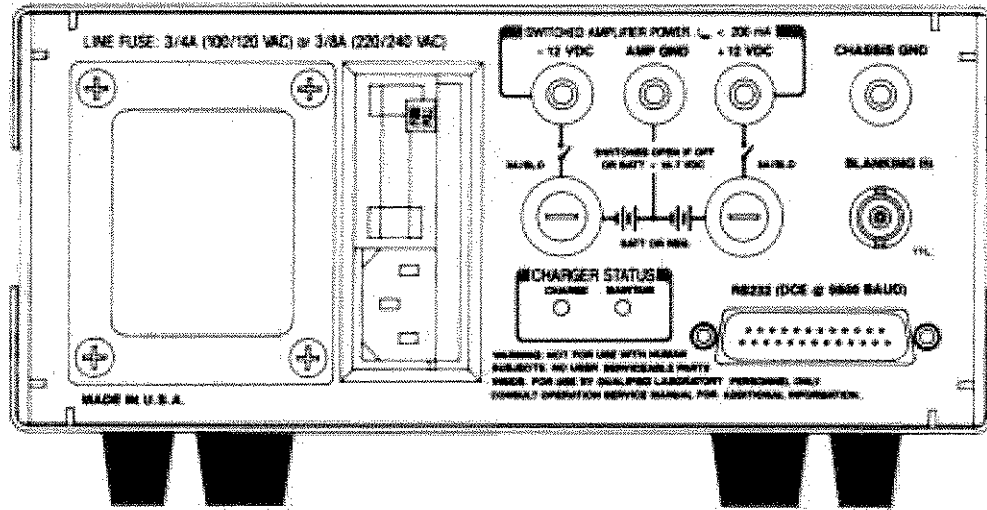

Figure 3: SR560 Rear Panel

REAR PANEL OPERATING SUMMARY

The SR560 rear panel is pictured in Figure 3. Various interface and power connectors are provided, along with fuses and charger status LEDs.

AC Power Input

The power entry module contains the receptacle for the AC line cord and fuse. The line fuse should be a 1 A slow-blow for 100/120 VAC operation, or a 1/2 A slow-blow for 220/240 VAC operation.

Amplifier Power Output

The -12 V, +12 V, and AMP GROUND banana jacks provide external DC power up to 200 mA for use as a bias source referenced to the amplifier's floating power supplies.

The CHASSIS GROUND banana jack is provided to allow the amplifier's ground to be referenced to the chassis. If the unit is connected to an AC power source via a three prong grounding plug, the chassis

ground is connected to the AC line ground conductor.

Battery Charger

The two 3 A slow-blow fuses protect the battery supply and charging circuitry. If these fuses are blown, battery power will be unavailable, and charging of the batteries will not be possible.

When both the positive and negative supply batteries are dead, the red "CHARGE" LED will be on brightly, and the batteries will be charging at a fast rate. When the batteries approach a fully charged condition, the charging current will be reduced to complete the charge and maintain the batteries. Because the batteries charge at different rates, the indicators on the rear panel can reflect the charge status of the positive and negative batteries independently. When one set of batteries switches to the "MAINTAIN" mode, the red "CHARGE" LED will be reduced to half brightness, and the yellow "MAINTAIN" LED will turn on at half brightness. When both batteries switch to "MAINTAIN", the red "CHARGE" LED will

OPERATION AND CONTROLS

turn off and the yellow "MAINTAIN" LED will be on full brightness.

Blanking Input

The blanking input accepts a TTL-level signal and grounds the amplifier signal path after the front end for as long as the input is held high. The response time of the blanking input is typically "on" 5 μ s after the rising edge and "off" 10 μ s after the falling edge.

RS-232 Interface

The RS-232 interface connector allows listen-only communication with the SR560 at 9600 baud, DCE. Communication parameters should be set to 8 bits, no parity, 2 stop bits. Data sent must be delimited by <CR> <LF>. All front panel functions excluding power and blanking, are available over the RS-232 interface. For more information on programming and commands, see Appendix A: Remote Programming.

BATTERY CARE AND USAGE

The SR560 can be powered from either an AC power source or from three 12 V, 1.9 Amp-hour maintenance-free sealed lead-acid rechargeable batteries. Integral to the SR560 is an automatic battery charger, along with battery protection and charge indication circuitry.

Recharging

During battery operation, the front panel BATT LED will change from green to red to indicate that the batteries are low and require charging. For the longest battery life, the batteries should be immediately charged by plugging the unit into AC power whenever the BATT indicator lights red. Internal protection circuitry will disconnect

the batteries from the amplifier if the unit is operated for too long in the low battery condition. This protects the batteries from permanent damage, which could occur if they were to remain connected to a load while dead.

The internal battery charging circuitry of the SR560 will automatically charge dead batteries at a quick rate until they are approximately 80% charged. The charge rate is then lowered to a level that is safe for maintaining the batteries. During AC operation, the batteries will be in this "maintain" charge condition indefinitely, and will suffer no degradation from prolonged charging. The sealed lead-acid batteries used in the SR560 differ in this respect from nickel-cadmium batteries, which do suffer shortened lifetimes due to overcharging. The sealed lead-acid batteries will provide the longest service life if they are not allowed to discharge too deeply and if they are charged immediately after use.

Battery Care

WARNING: As with all rechargeable batteries, for safety reasons the chemical recombination processes within the cells require that the batteries be allowed to vent non-corrosive gases to the atmosphere. Always use the batteries in an area with adequate ventilation.

As with all instruments powered by rechargeable batteries, the user must take some precautions to ensure long battery life. Understanding and following the precautions outlined below will result in a long operating life for the batteries in the SR560.

The SR560's internal lead-acid batteries will have a variable service life directly affected by THE NUMBER OF DISCHARGE CYCLES, DEPTH OF DISCHARGE AND AMBIENT TEMPERATURE. The user should follow these simple guidelines below to ensure longest battery life.

